



---

# CATALOGUE

---

**LED's grow**



# Summary

## Presentation

Plants and light	4
Vegeled™ horticultural LED lighting	4
Who is Vegeled™'s offer destined to ?	5
Strong points	5

## Products

Products range	8
Spectral range	10

## Technical datasheets

Details	14
Vegeled™ Aurora Series horticultural lamps	14
Vegeled™ Pandora Plus Series horticultural lamps	15
Vegeled™ Apollo G2 Series horticultural lamps	16
Vegeled™ Eos Series horticultural profiles	17
Vegeled™ Asteria Series horticultural tiles	18
Civilight Series photoperiodic horticultural bulbs	19
Vegeled™ growing trolley	20

## Services

Audit	22
Custom project	23

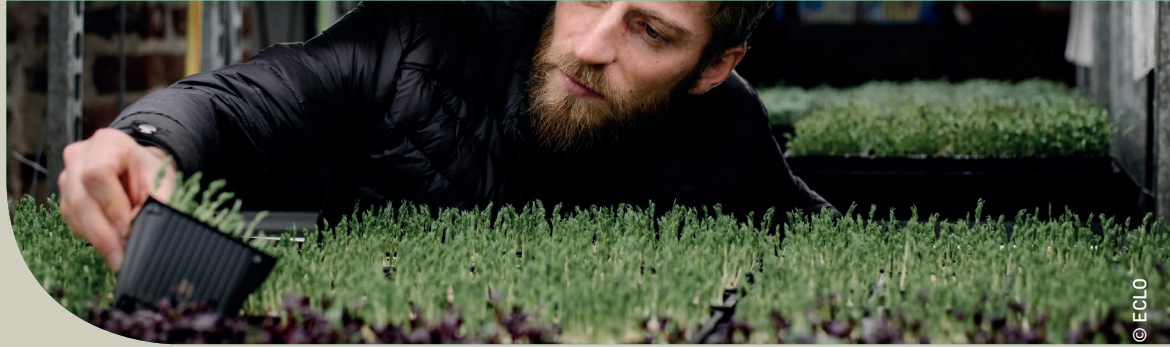

# PRESENTATION

## PLANTS AND LIGHT

Light is essential for plant growth through the process of photosynthesis and other regulating processes.

If natural light from the sun is the most abundant and cheapest source, it is difficult to control however in terms of spectral composition, intensity and time of illumination.

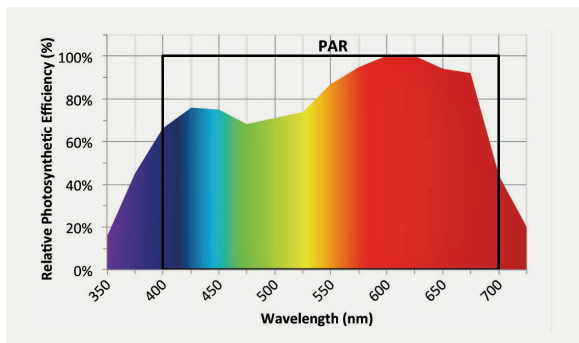

Average photosynthetic response of 22 species of plants grown in a growing chamber (taken from numerical data of McCree, 1972)

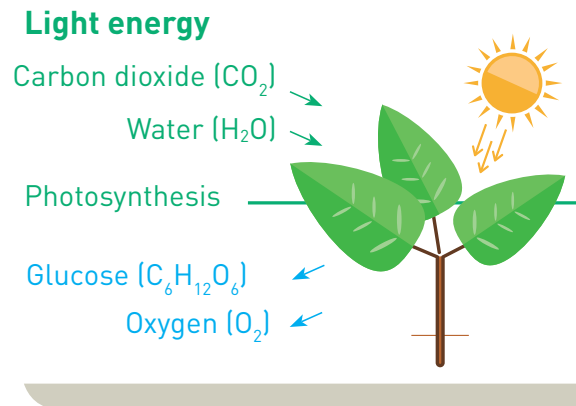

The use of artificial light has become very common therefore, for increasing plant production. The latest technical and scientific advances allow the delivery of light to the plants to be controlled, allowing you to illuminate with the spectrum and photoperiods, best adapted to the applications.

## VEGELED™ HORTICULTURAL LED LIGHTING

With this in mind, **Colasse SA** has developed a range of horticultural lighting products based on LED technology, sold under the **Vegeled™** brand. These products are the result of several years of research for optimising horticultural LED lighting of plants grown in greenhouses and in the laboratory.



This research project started in 2009 in collaboration with the **CARAH** ASBL research centre affiliated with the HEPH-Condorcet Higher Education School, thanks to the support of the Walloon region. **Colasse SA** continues its progress and now collaborates with many other centres and producers throughout the world with the goal of delivering efficient, innovative, horticultural LED lighting systems.

# WHO IS VEGELED™ DESTINED TO ?

The **Vegeled™** range is composed of a series of LED lamps, LED profiles and accessories which allow the needs of **all types of customers active in horticulture**, to be met efficiently, whether as fruit and vegetable producers or as individuals.

Wanting to best serve its customers and to develop long-lasting partnerships with them, **Colasse SA** has placed all its savoir-faire at their disposal in order to provide the most suitable solutions. Thus, the **Vegeled™** offer goes from the simple supply of LED lighting components to on-site installation in collaboration with certified partners and with the assistance of design offices.

## STRONG POINTS



### LIGHTING ADAPTABLE TO EACH APPLICATION

**Vegeled™** products can be defined in a very large range of spectral combinations thanks to a total mastery of their manufacturing process. **We can produce customised LED matrices and LED tapes** and thus reproduce practically any light spectrum homogeneously.

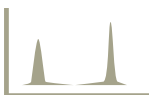

### FLUX AND SPECTRAL STABILITY OVER TIME

Particular attention is paid to the quality and reliability of the LEDs that we select. We especially, also make sure that they are properly cooled by using heat sinks in the form of aluminium fins. This allows the LEDs to be maintained in the proper operating conditions so as to conserve their service life. This extends from 30,000 to 50,000 hours depending on the ambient temperature.

In addition, **the decrease in luminous flux of Vegeled™ products is very slow, gradual and without noticeable change of the spectral combination.** As an example, our bi-phosphor white LEDs used in the manufacture of our **Vegeled™** lighting profiles, only display a loss of flux of 1% after 6000 hours of operation according to the IESNA LM-80 test.



## BETTER LUMINOUS EFFICIENCY THAN DISCHARGE LAMPS

Thanks to a higher luminous flux output/watt and the possible optimisation of the spectrum, **Vegeled™ horticultural LED lighting systems have a much higher energy efficiency than discharge lamps.**



## CONTROL OF THE LIGHTING RHYTHM

All **Vegeled™** equipment is available in dimmable versions. **The light intensity of the products can therefore be modulated as necessary and if desired.** The control system is adapted to the situation so as to facilitate its use. The use of digital controls allows the reproduction of chosen lighting conditions to be guaranteed.

We also have our own control system that allows you to play with the spectral composition, light intensity and photoperiod.



## LOCAL MANUFACTURE FOR TOTAL QUALITY CONTROL

**Vegeled™ rails are 100% designed and assembled in Belgium.** The lamps are assembled by our partner following specifications drafted by our teams. The raw materials, manufacturing steps and finished products undergo systematic and rigorous quality control **in Belgium.**



## RED/BLUE SPECTRUM VS BROAD SPECTRUM

Working in a fuchsia colored environment is not pleasant. **Vegeled™ spectra have a wide spectrum and often a high color rendering index (CRI),** thus making your work easier in a growing zone.

Moreover, research on the lighting needs of plants has evolved greatly over the last few years and tends to dispute the idea that plant growth is only stimulated by two colors.

Complete spectra are produced by a combination of white and monochromatic LEDs and have always been the hallmark of **Vegeled™.**



## GROWTH BUT EVEN MORE

Our research has not been limited to the optimisation of plant growth. The choice of spectral combination in fact, can act on the shape and the taste of certain plants.

In collaboration with some of our customers **we have also developed lighting systems to ensure the development of complete ecosystems.**



## HIGH IP CODES FOR DIFFICULT ENVIRONMENTS

Some applications require the equipment to have a high IP Code. We are able to offer **lamps with IP65 and rails with IP68 if need be.**



# PRODUCTS

# PRODUCTS RANGE

## Aurora Series



Growth chambers and greenhouses

Dimmable

IP65

Medium to long distance lighting

High light intensity

Replacement of HPS 400W lamps

## Pandora Plus Series

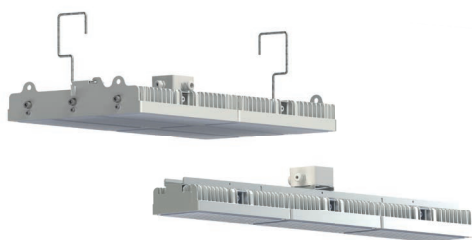

Growth chambers and greenhouses

Dimmable

IP65

Medium to long distance lighting

High light intensity

Compact or linear design

Replacement of HPS 400W, 600W and 1000W lamps

## Apollo G2 Series



Growth chambers and greenhouses

Dimmable

IP65

Medium to long distance lighting

High light intensity

Variable optics

Multi-spectral



## Eos Series



### Multi-layer growing systems

Dimmable

IP40 / IP44 / IP68

Short to medium distance lighting

Medium to low light intensity

Multi-spectral

## Asteria Series

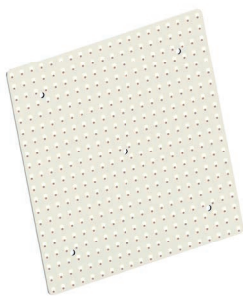

### Multi-layer growing systems

Dimmable

IP20 / Tropicalisation coating

Short to medium distance lighting

Medium to low light intensity

## Civilight Series



### Growth chambers and greenhouses

Non-dimmable

IP44

Photoperiodic lighting

Low light intensity

Replacement of incandescent (100W) and eco-halogen (75W) lamps

## Growing trolley



### Complete growing systems

Danish trolley

3 to 4 height adjustable growing shelves

LED profiles from the Eos Series

Ebb & flow irrigation system (in option)

Irrigation and photoperiod management (in option)

# SPECTRAL RANGE

In both research and production, we believe that a single solution does not meet all needs. Therefore, we have created a series of spectra offering great flexibility depending on the type of plant, the objective of cultivation or the location.

## WHITE / RED

### T1 SPECTRUM

PPF ratio	
UV (380-399 nm)	0,05%
BLUE (400-499 nm)	5,07%
GREEN (500-599 nm)	10,75%
RED (600-699 nm)	83,08%
FR (700-780 nm)	1,05%
PAR (400-700nm)	98,90%

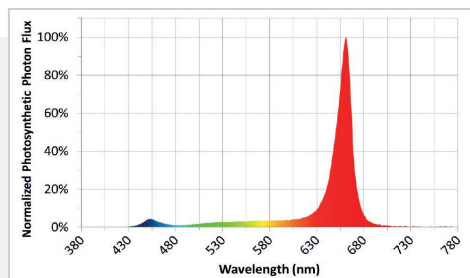

### P1 SPECTRUM

PPF ratio	
UV (380-399 nm)	0,04%
BLUE (400-499 nm)	10,21%
GREEN (500-599 nm)	21,73%
RED (600-699 nm)	66,43%
FR (700-780 nm)	1,59%
PAR (400-700nm)	98,37%

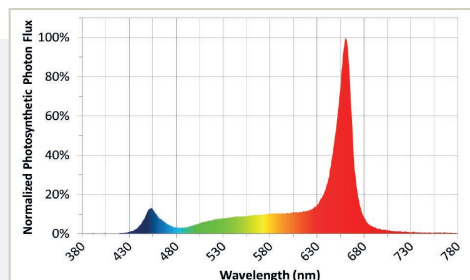

### M1 SPECTRUM

PPF ratio	
UV (380-399 nm)	0,05%
BLUE (400-499 nm)	16,16%
GREEN (500-599 nm)	37,30%
RED (600-699 nm)	44,91%
FR (700-780 nm)	1,58%
PAR (400-700nm)	98,37%

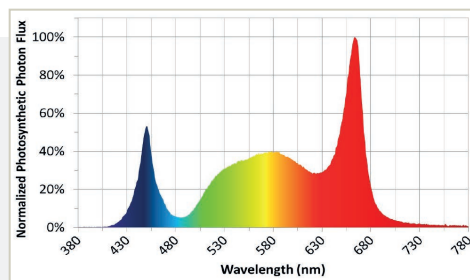

### A1 SPECTRUM

PPF ratio	
UV (380-399 nm)	0,17%
BLUE (400-499 nm)	16,56%
GREEN (500-599 nm)	38,28%
RED (600-699 nm)	41,93%
FR (700-780 nm)	3,06%
PAR (400-700nm)	96,77%

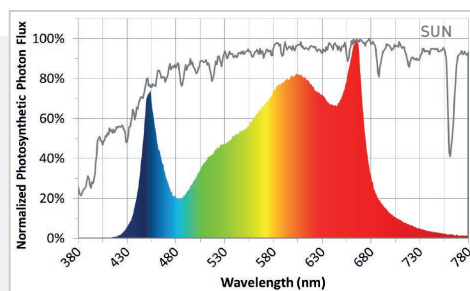

From the most energy-efficient solution to the most complete spectrum.

# WHITE

## N1 SPECTRUM

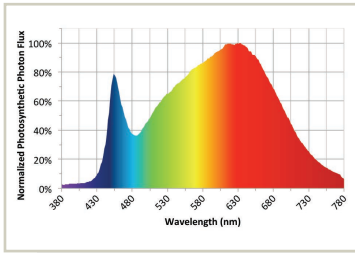

PPF ratio	
UV (380-399 nm)	0,26%
BLUE (400-499 nm)	15,73%
GREEN (500-599 nm)	35,82%
RED (600-699 nm)	40,11%
FR (700-780 nm)	8,09%
PAR (400-700nm)	91,65%

## S1 SPECTRUM\*

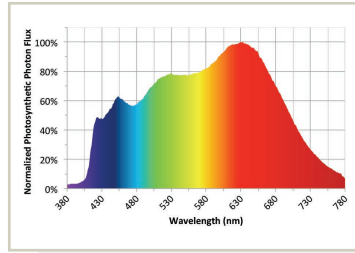

PPF ratio	
UV (380-399 nm)	0,27%
BLUE (400-499 nm)	20,93%
GREEN (500-599 nm)	33,64%
RED (600-699 nm)	37,00%
FR (700-780 nm)	8,16%
PAR (400-700nm)	91,57%

\*Availability depending on the country

## W1 SPECTRUM

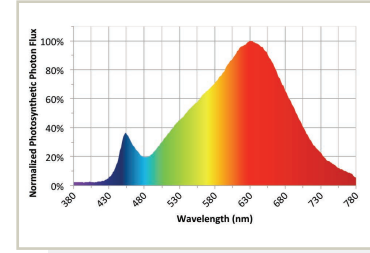

PPF ratio	
UV (380-399 nm)	0,21%
BLUE (400-499 nm)	9,82%
GREEN (500-599 nm)	32,61%
RED (600-699 nm)	48,18%
FR (700-780 nm)	9,18%
PAR (400-700nm)	90,61%

# EXTRA FAR RED

All **Vegeled™** spectra can be completed by far red of which we are convinced of its interest in many applications.

Examples :

## T1FR SPECTRUM

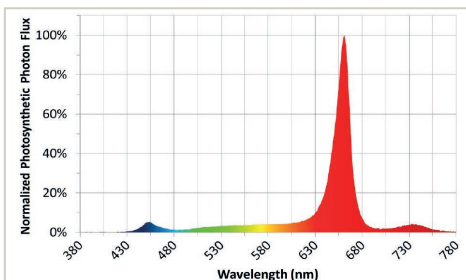

## N1FR SPECTRUM

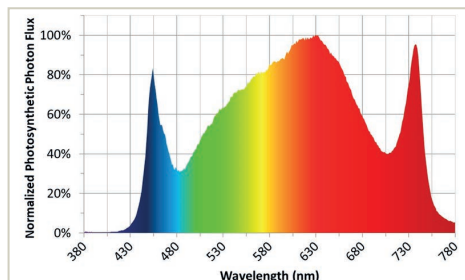

# MULTI-SPECTRAL SOLUTION

For research applications or for persons wishing to create their own light recipe, we have developed multi-spectral solutions on our platforms. These solutions are accompanied by a complete spectral control system. Possibilities of control and customization on request.





## TECHNICAL DATASHEETS

# DETAILS

## VEGELED™ HORTICULTURAL LAMPS

### AURORA SERIES



The Aurora series is a series of lamps suitable for replacing HPS 400W lamps.

As a one-to-one substitute, it saves around 30% of the power for a light gain of 10 to 20%.

The compact, light format has a single fastening using a suspension hook.

Product type	Vegeled™ Aurora series
Model	LA300
Power consumption	300-325W
Input voltage	100-277VAC/347-480VAC; 50/60Hz
Power factor	>95
Beam angle	120°
Dimmable	Option : 0-10V, PWM
Water and dust protection	IP65
Thermal management	Passive
Dimensions (L x w x h)	460x460x197
Weight (driver incl.)	9.6kg
Color casing	White (black as option)
Cable length	2m
Life span	50 000h (L90>36 000h)
Certifications	CE, RoHS ((c)JETL pending)
Warranty period	5 years

### Mounting accessories

#### Options



Hanging cable



Hanging hook

### Dimensions

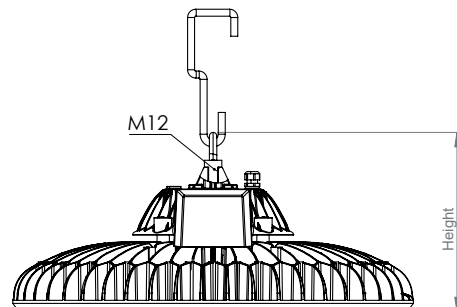
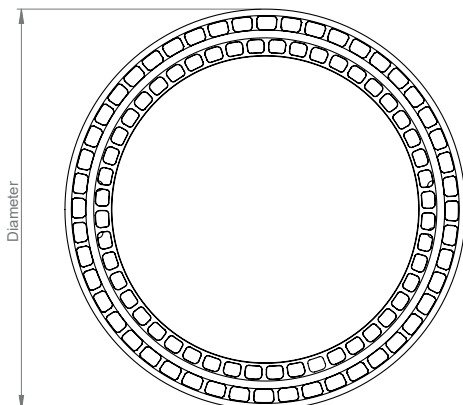

# VEGELED™ HORTICULTURAL LAMPS

## PANDORA PLUS SERIES

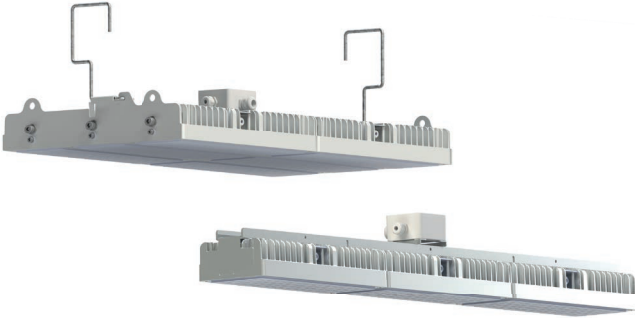

The Pandora Plus series consists of various modules that can be combined with each other to create a variety of power levels and luminaires.

The different models are suitable for replacing HPS 400, 600 and 1000W lamps. As a one-to-one substitute, it saves around 35% of the power for the same amount of light.

Product type	Vegeled™ Pandora Plus series			
Model	LB302	LB402	LB602	LB1K0
Configuration	3x1	2x2	3x2	3x2
Power consumption	300-325W	400-433W	600-649W	1000-1050W
Input voltage	200-305VAC, 108-305VAC 50/60Hz			
Beam angle	120° (30°, 60°, 90°, asymmetric)			
Dimmable	Option : 0-10V, PWM			
Water and dust protection	IP65			
Thermal management	Passive			
Dimensions (L x w x h)	900x107x96	634x218x96	626x326x96	626x326x96
Weight	5.1kg(+1.6)	6.8kg(+2.65)	10.15kg(+3.35)	10.15kg(+3.35)
Color casing	White (black as option)			
Cable length	60cm			
Life span	50 000h (L90>36 000h)			
Certifications	CE, RoHS ((c)ETL pending)			
Warranty period	5 years			

### Mounting accessories

#### Options



Hanging cables



Hanging hooks

### Dimensions

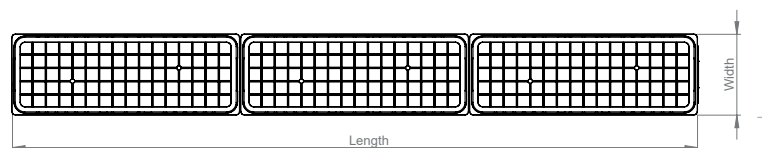
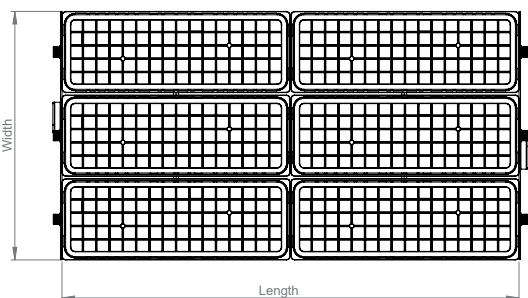
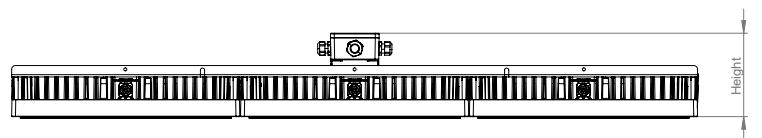
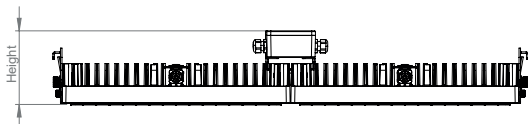

# VEGELED™ HORTICULTURAL LAMPS

## APOLLO G2 SERIES



**Vegeled™** lamps of the Apollo series are specially adapted for growth in environmental chambers and in difficult environments.

The equipment, equipped with an ultra-efficient, passive cooling system, comes in a wide number of variants which allows you to adapt it to any type of situation.

The Apollo series is also our only range of multi-spectral floodlights available.

Product type	Vegeled™ Apollo G2 series		
Model	LL152	LL252	LL302
Power consumption	150-165W	250-275W	300-330W
Input voltage	200-305VAC, 108-305VAC 50/60Hz		
Beam angle	120° (30°, 60°, 90°, asymmetrical)		
Dimmable	Option : 0-10V, PWM		
Water and dust protection	IP65		
Thermal management	Passive		
Dimensions (L x w x h)	411x367x244	562x367x244	562x367x244
Weight	8.2kg	11.1kg	11.1kg
Color casing	White (black as option)		
Cable length	2m		
Life span	50 000h (L90>36 000h)		
Certifications	CE, RoHS ((c)ETL pending)		
Warranty period	5 years		

### Dimensions

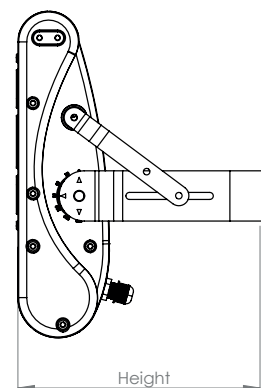
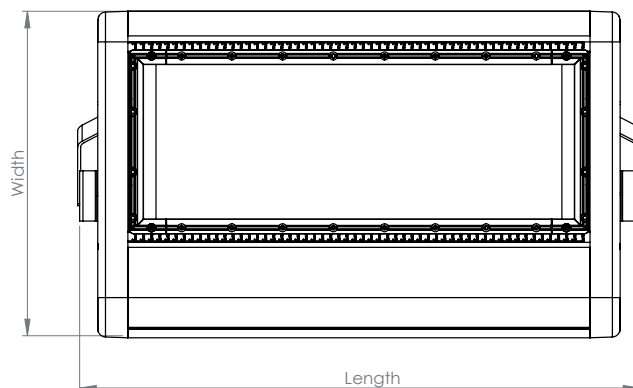



# VEGELED™ HORTICULTURAL PROFILES

## EOS SERIES

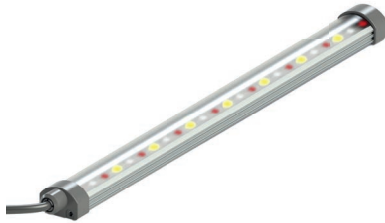

The **Vegeled™** Eos series is ideal for lighting multi-layer growth systems with low to medium light intensity.

The LED profiles come in three different IP Indices and are custom manufactured depending on the project. Their ease of design and their large range of available spectra make our lighting product the most flexible.

Product type	Vegeled™ Eos series
Model	CE023
Power consumption	23-24W/m
Input voltage	24VDC
Beam angle	120°
Dimmable	Option : 0-10V, PWM, DALI, DMX
Water and dust protection	IP40 (IP44 and IP68 upon request)
Thermal management	Passive
Dimensions (L x w x h)	Lx22x14 <sup>1</sup>
Weight	~0.235kg/m
Cable length	1m
Life span	36 000h
Certifications	CE, RoHS
Warranty period	3 years

<sup>1</sup>The LED rails can be manufactured up to 3 meters long.

### Mounting accessories

#### Options



Fixing clips



Power supply kit

### Dimensions

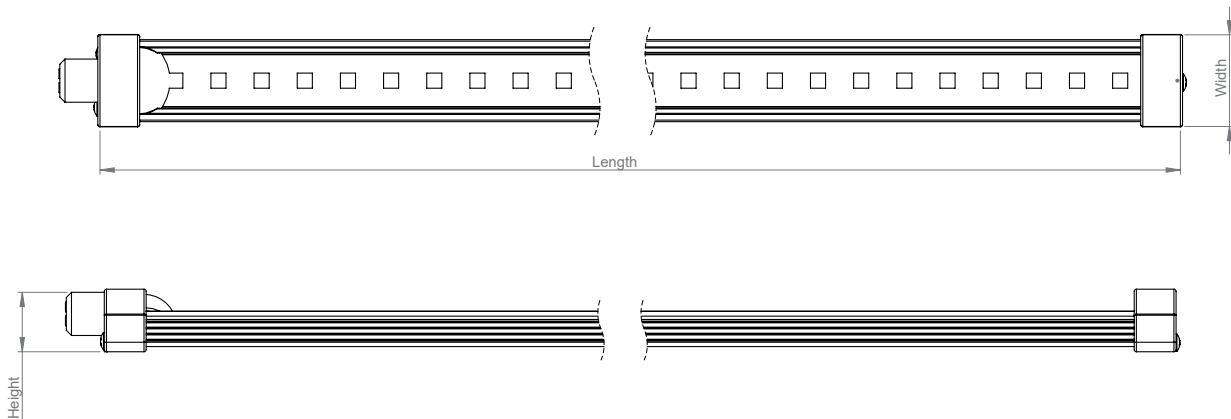

# VEGELED™ HORTICULTURAL TILES

## ASTERIA SERIES

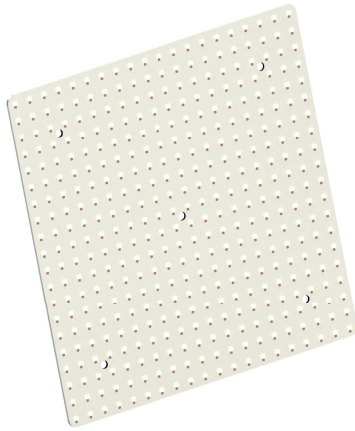

The LED panel series is suitable for lighting projects where very high homogeneity is required at short distances.

The series is designed for low to medium intensity applications and is particularly suitable for multi-layer growth systems.

Product type	Vegeled™ Asteria Series		
Model	UA007	UA028	UA048
Power consumption	7W	28W	48W
Input voltage	24VDC	24VDC	48VDC
Beam angle	120°		
Dimmable	Option : 0-10V, PWM, DALI, DMX		
Water and dust protection	IP20		
Thermal management	Passive		
Dimensions (L x w x h)	300x300x2	300x300x2	500x350x2
Weight	0.538kg	0.538kg	1.014kg
Cable length	1m		
Life span	36 000h		
Certifications	CE, RoHS		
Warranty period	3 years		

### Mounting accessories

— Options —



Power supply kit

### Dimensions

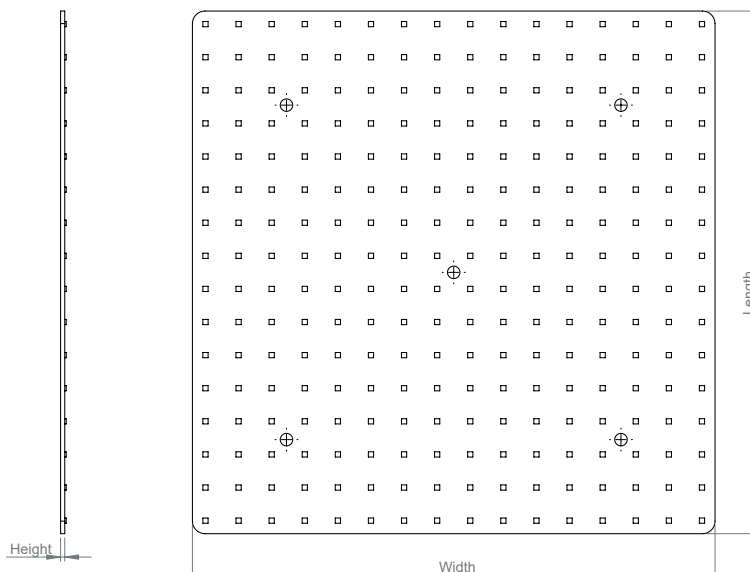

# PHOTOPERIODIC HORTICULTURAL BULBS

## CIVILIGHT SERIES



The BR40 CIVILIGHT photoperiodic, horticultural, grow lighting bulb is suitable for replacing incandescent (100W) and halogen (75W) lamps. As a one-to-one substitute, the bulb allows an energy saving of 80 to 85%.

Its special spectrum is used to break dormancy, to strengthen the growth and to stimulate flowering. The additional white light creates a more pleasant environment for workers.

The compact and lightweight format is easily hung without modification of the existing installation thanks to its E27 fitting.

Product type	CIVILIGHT Series
Model	BR40
Power consumption	15W
Input voltage	90-264VAC; 50Hz
Power factor	>90
Beam angle	100°
Dimmable	No
Water and dust protection	IP44
Thermal management	Passive
Dimensions (Ø x h)	125x156
Weight	310g
Socket	E27
Working temperature	40°C
Switching cycles	100 000
Life span	L70>50 000h; L90>25 000h
Certifications	CE, RoHS
Warranty period	3 years

### Mounting accessories

#### Options



Cable



E27 Socket

### Dimensions

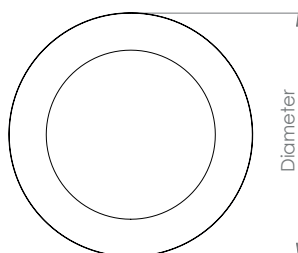
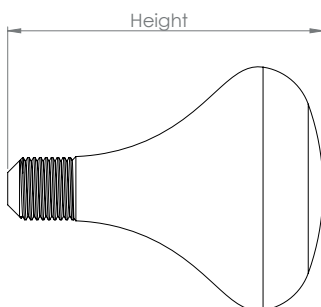

Tested by



PROEFCENTRUM  
HOOGSTRATEN

# VEGELED™ GROWING TROLLEY

The **Vegeled™** growing trolley is an easy to use system intended for research or production.

The solution is shown in the standard format of a Danish trolley equipped with a lighting and optional irrigation system.

The trolley can be configured with any existing **Vegeled™** lighting profiles and can be powered from a simple electrical outlet. The solution is delivered as a do-it-yourself assembly kit.

## Typical configuration

- Danish trolley with dimensions 134x56x210cm
- 3 to 4 height adjustable growing shelves
- Water retention tables with dimensions 126x56x5cm
- 2 to 14 mono- or multi-spectral LED profiles
- PLUG & PLAY connection system

### 230V Master control box :

- Watering time management
- Photoperiod management
- Maximum total power 3.5kW

### Slave control box :

- Communication interface between trolleys
- Lighting plug in
- Pump plug in (option)



## Options

- Multi-spectral control
- Ebb & Flow irrigation system with water tank and integrated pump
- Possibility of electrically connecting several trolleys together : master/slave system



## SERVICES



## AUDIT

In order to offer our customers the best adapted solution for optimising their artificial lighting, we propose a systematic stepped approach.



### Site visit

During this visit, we identify what the needs are in terms of light intensity and spectral quality, depending on the plants envisaged. Using our portable spectrometers, we can take very precise measurements of the light spectra of the existing equipment.

In view of the design of a lighting improvement solution, we also take into account, the technical requirements such as the architecture of the building, the heating and ventilation system, etc. The safety and comfort of personnel who must work in the lighted zones, are also some of our preoccupations.



### Report

We develop a proposal for improvement on the basis of customer needs and technical and safety constraints. If this proposal leads to an investment in terms of **Vegeled™** lighting equipment, a costed proposal will also be drafted and presented. In collaboration with the customer, we can also perform a calculation of profitability in so far as the elements of the calculation are given to us.



## CUSTOM PROJECT

Thanks to its high flexibility and capacities in terms of research and innovation, **Colasse SA** is able to design and manufacture complete artificial lighting systems to promote plant growth and vitality.



© ECLIO

### These projects can include

- Lamp replacement or supply of growth shelves
- Lamp replacement for phytotrons and growth chambers
- Implementation of greenhouse supplementary lighting
- Design of lighting systems for vertical farms
- Co-research













Led Lighting Solutions

---

Rue Puits-Marie 79 - 4100 Seraing - Belgium - [www.colasse.be](http://www.colasse.be)  
vegeled@colasse.be - Phone : +32 4 225 25 89 - Fax : +32 4 365 13 76